

NOTE:

Suitable for 80*80 or 86*86 face plate
 4-sided and one-Bottom cable inputs
 Suitable for power socket or switch installation
 Outdoor Application
 For wall or desktop Mounting

Accessories:

Expansion screw: ST-4*30 *4 set (wall-mounting)
 Rubber mat: 4pcs(waterproof after mounting)
 Fixed iron : L:100mm *2 pcs (face plate mounting)
 screw: ST-3*10*4pcs / ST-3.5*17*4 pcs
 Input: PG13.5 * 2 pcs
 user guide: 1pc
 RoHS3.0 CE IP66 Complinat
 Operating temperature:-20~+60°C
 Storage temperature:-40~+70°C
 Operation humidity:10%~85%
 Storage humidity:10%~85%
 Packing:1pc/PE BAG INNER BOX

MATERIAL LIST:

③	Cover	PC Black	1	
②	Middle Frame	ABS Gray	1	
①	Bottom box	ABS Gray	1	
NO.	PARTS NAME	SPECIFICATION DESCRIPTION	QT' Y	REMARK
		NEW	2022-08-04	A
BY	CHK	REVISION RECORD MODIFICATIONS	DATE	REV.

SYNERGY21

CUSTOMER		ITEM NO.	S216381		
PRODUCT NAME	IP66 waterproof outdoorbox	manufacture country:	CHINA	UNIT	MM
DRAWNBY	CHECKBY	APPOBY	DATE		
SYNERGY21	SYNERGY21	SYNERGY21	2022-08-04		

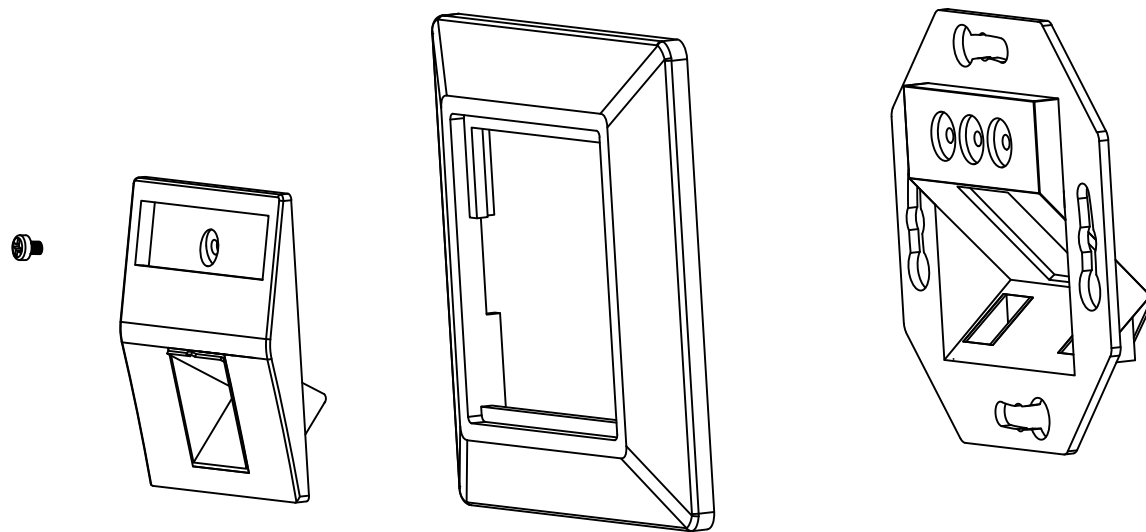

Chart:

ITEM NO	COLOUR
S216322V2	pure white, RAL9010

Materials:

Outlet Housing: ABS UL-94V2/Colour:see the chart

Outlet Base: ABS UL-94V2/Colour:see the chart

Metalic Plate:Al&Zn Alloy /Al&Zn Alloy,

ACCESSORY :

- 1.Label
- 2.Plastic gasket
- 3.Screw:M4*9*2Pcs

Storage Temperature: -40°C--+70°C

Operation Temperature:-10°C--+60°C

RoHS 3.0&REACH Compliant

Packing:PE bag+label

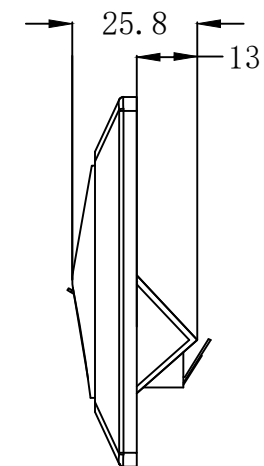
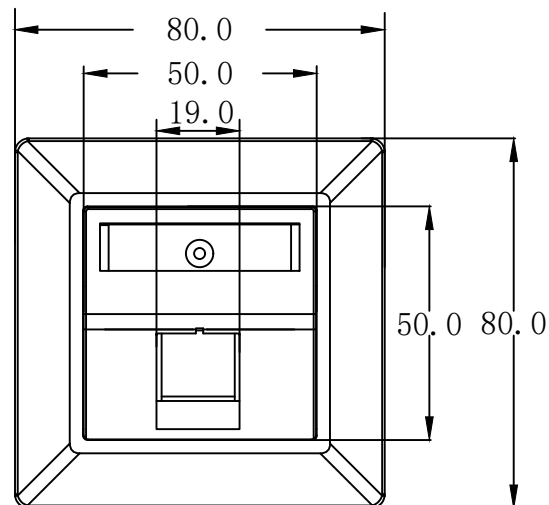

SYNERGY 21

		CUSTOMER		ITEM NO.		see the chart		
		PRODUCT NAME	FRAME SET 1PORT	manufacture country	China	UNIT	MM	
		NEW	2022-08-04	A	DRAWNBY	CHECKBY	APPOBY	DATE
BY	CHK	REVISION RECORD MODIFICATIONS	DATE	REV.	SYNERGY 21	SYNERGY 21	SYNERGY 21	2022-08-04

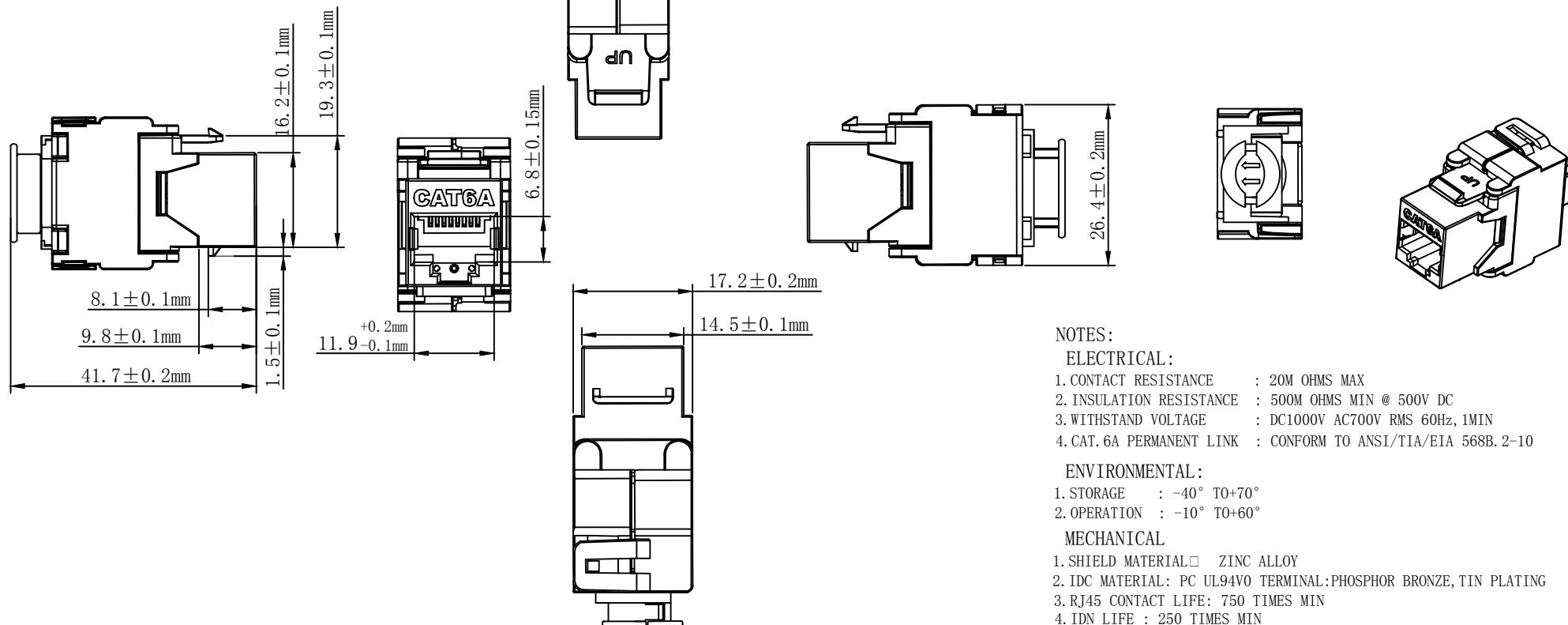

NOTES:

ELECTRICAL:

- CONTACT RESISTANCE : 20M OHMS MAX
- INSULATION RESISTANCE : 500M OHMS MIN @ 500V DC
- WITHSTAND VOLTAGE : DC1000V AC700V RMS 60Hz, 1MIN
- CAT.6A PERMANENT LINK : CONFORM TO ANSI/TIA/EIA 568B.2-10

ENVIRONMENTAL:

- STORAGE : -40° TO+70°
- OPERATION : -10° TO+60°

MECHANICAL

- SHIELD MATERIAL ZINC ALLOY
- IDC MATERIAL: PC UL94V0 TERMINAL:PHOSPHOR BRONZE, TIN PLATING
- RJ45 CONTACT LIFE: 750 TIMES MIN
- IDN LIFE : 250 TIMES MIN
- RJ45 DIMENSION:11.9MM*9.8MM
- WEIGHT: 34.7G

TYPE

- SHIELDED CAT.6A KEYSTONE JACK
- COLOUR:SILVERY WHITE

RoHS 2.0 and REACH Compliant

Support PoE per IEEE 802.3af, PoE+ per IEEE

802.3at

PACKING: 1pcs+Copper foil included/PE bag+label

1, 50pcs/box+label 2, 250pcs/ctn+label 1

MATERIAL LIST:

⑦	MODULAR COVER	FIREPROOF PC UL94V0	1	
⑥	RJ 45 JACK INSERT	8P8C 3U" GOLD PLATED	8	
⑤	PCB	1.6mm UL 94V0	1	
④	IDC BODY	FIREPROOF/PC UL 94V0	1	
③	IDC PIN	PHOSPHOR BRONZE & TINNED	8	
②	LABEL COLOR CODE	T568A/B	2	
①	IDC TERMINAL	FOR 22-26AWG CABLE	1	

NO.	PARTS NAME	SPECIFICATION STANDARD	QT' Y	REMARK
		UPDATE PACKING TYPE	2018-03-20	A1
		NEW	2011-07-11	A
BY	CHK	REVISION RECORD MODIFICATIONS	DATE	REV.

SYNERGY 21				
CUSTOMER			ITEM NO.	S216310
PRODUCT NAME	CAT.6A STP KEYSTONE JACK	manufacture country	China	UNIT MM
DRAWNBY	CHECKBY	APPOBY	DATE	
SYNERGY 21	SYNERGY 21	SYNERGY 21	2018-03-20	

Montageanweisung

Cat.6/Cat.6A Modul und Rahmenset



Außenmantel des Verlegekabels ca.4 cm abnehmen und Gesamtschirmung nach hinten ziehen.
Strip off approx. 4 cm of the cable jacket and fold total shield back over it.

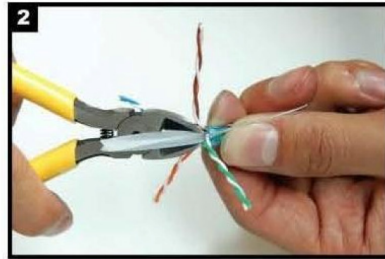

Paarfolie entfernen.
Remove pair shielding.



Der Kabelsortierer verfügt über beide Farbcodes(568A/B).Wählen Sie den entsprechenden Farbcode.
Please choose colour code 568A or B according your application.

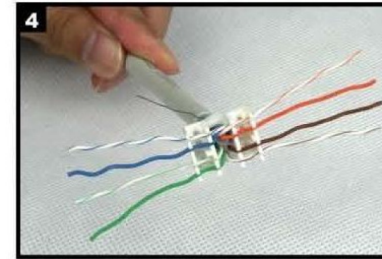

Kabel einführen und die einzelnen Adern nach der von Ihnen gewählten Belegungsvariante in den Kabelsortierer einführen.
Insert the cable into the termination cap and fan out all four twisted pairs following the colour code printed on the termination cap. Make sure that all conductors are in the proper slot.

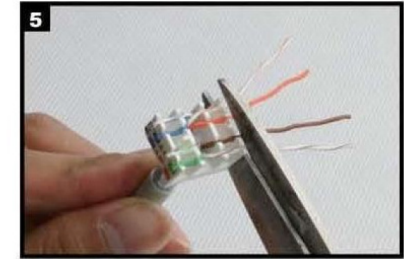

Überstehende Adern abschneiden.
Trim the ends of the conductors.

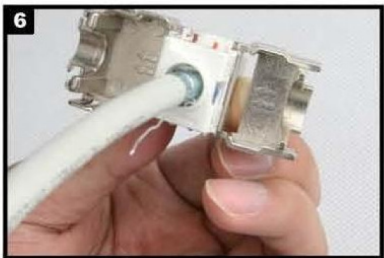

Den Sortierer in Pfeilrichtung in das Modul einsetzen.Bitte Pfeilrichtung beachten!
Install the termination cap in direction of arrow into the Keystone Jack.



Die Montageklappen schließen -mit diesem Vorgang wird das Modul kontaktiert.
Press both covers of the Keystone Jack to contact the cable.

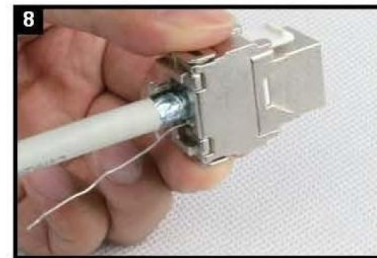

Ggf. die Arretierung nochmals kontrollieren und schließen.
Control the operation and close the Keystone Jack finally.



Die 180°Schirmschelle aufsetzen.
Install the 180° shielding clamp.

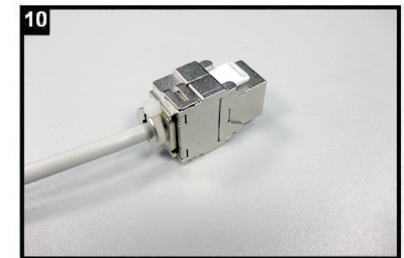

Das Modul mit dem Kabelbinder zugentlasten und die Schirmschelle fixieren.
Use cable tie for strain relief and to fix the shielding clamp.

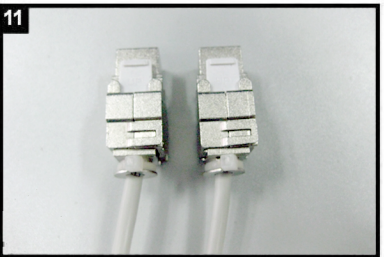

Für eine Doppeldose werden 2 Module benötigt.
For a dual port wall outlet 2 Keystone jacks are needed.

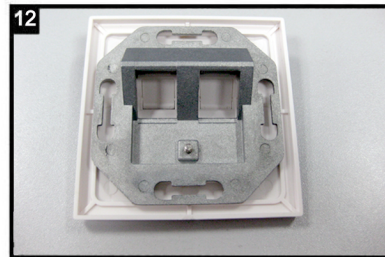

Montieren Sie das Rahmenset bestehend aus Modulträger und Abdeckung.
Assemble the metal frame and the coverplate.

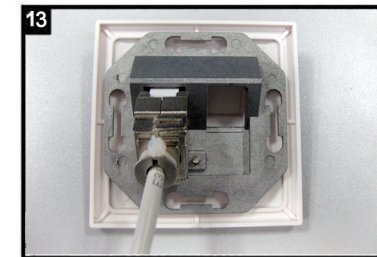

Befestigen Sie das erste Modul durch Einclippen im Modulträger.
Assemble the first Keystone Jack with snap in operation in the metal frame.

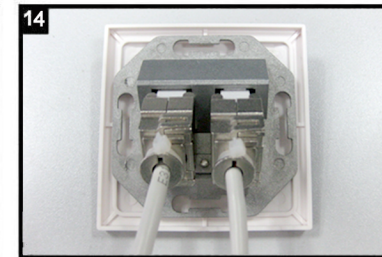

Dann befestigen Sie das zweite Modul im Modulträger.
Assemble the second Keystone Jack in the same way.



Die Cat.6/Cat.6A Doppeldose ist fertig montiert.
The Cat.6/Cat.6A dual port Wall Outlet is ready for use.