



Mi • Light Subordinate New Brand

6W RGB+CCT LED Garden Light+Power Cable Kit

Model No.: FUTC08A

1. Features

- RGB+CCT 16 Millions of colors to choose
- Signal transmitting & Modes synchronization
- Remote control Control distance 30m
- Color temperature 2700~6500K
- Waterproof and dustproof grade IP66
- Smart phone APP control (2.4GHz gateway is needed)
- Dimmable Saturation control
- 2.4G RF wireless transmission technology
- Support third party voice control (2.4GHz gateway is needed)
- Beam angle 25° Illumination distance more than 10m

2. Parameters

RGB+CCT LED Garden Light (DC24V)

- Input Voltage: DC24V
- CRI: >80
- Power: 6W
- Beam Angle: 25°
- Working Temp.: -20~45°C
- Illumination Distance: >10m
- Color Temp.: 2700K~6500K
- IP Rate: IP66
- Luminous Flux: 550LM
- RF: 2.4GHz
- Light Efficiency: 90LM/W
- Transmitting Power: 6dBm
- Lifespan: 50000 hours
- Control Distance: 30m

Switching Power Supply

- Input Voltage: AC100~240V 50/60Hz
- Rated Input Current: 1.5A Max.
- Power Consumption(no loading): 0.21W Max.
- Configuration: II Conductor
- Output Voltage: DC24V
- Rating Load Current: 2.7A
- Rating Output Power: 65W
- Working Temp.: 0~45°C
- Storage Temp.: -20~80°C

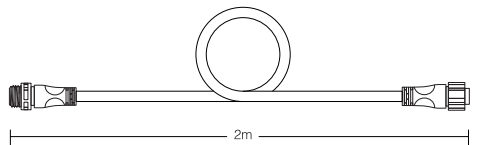
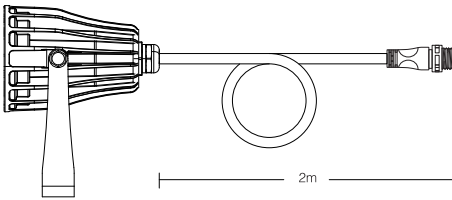
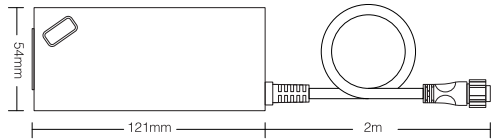
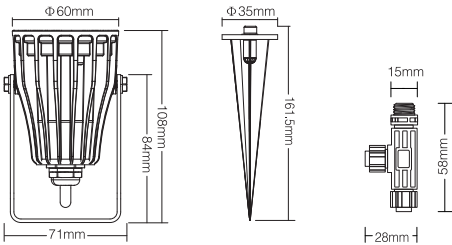

www.futlight.com
Made in China



Signal transmitting & Modes synchronization

3. Connection Diagram

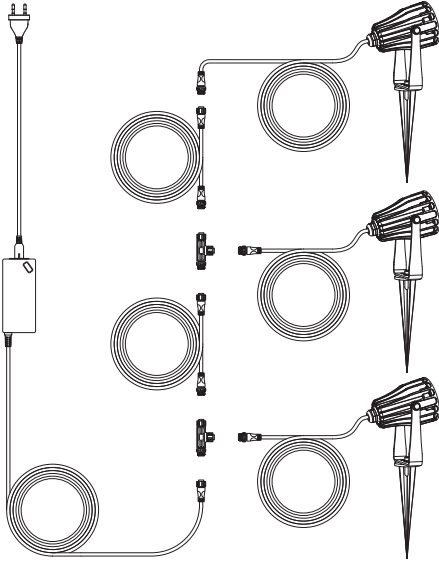

4. Link/Unlink

Compatible with these remote controls
(Purchased separately)

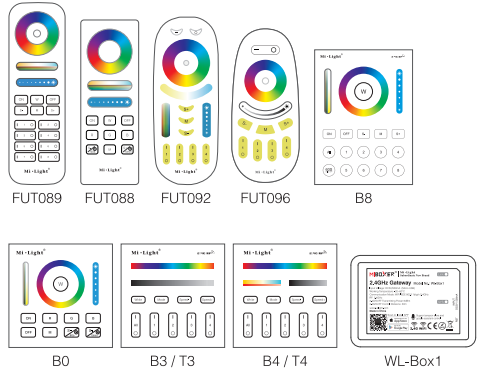

⚠️ NOTE:

Lighting can be working after linking with remote;
for more details, pls read the remote instruction.

5. Signal transmitting

One garden light can transmit the signals from the remote control to another garden light within 30m, as long as there is a garden light within 30m, the remote control distance can be limitless.

6. Modes synchronization

Different garden light can work synchronously when they are started at different times, controlled by the same remote, under same dynamic mode and within 30m distance.

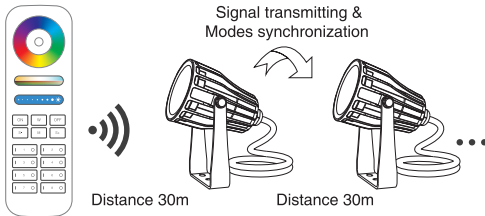









7. Dynamic Mode Sheet

Number	Dynamic Mode	Brightness / Saturation / Speed
1	Mardi Gras	Adjustable
2	Automatic color change	
3	Sam	
4	Gemstone	
5	Twilight	
6	American	
7	Fat Tuesday	
8	Party	
9	Slow Color Splash	

8. Attention

- When install the lighting fixtures, pls switch off the power to make sure the safety.
- Please check whether the input voltage supply is in accordance with the lighting fixtures.
- Non-professional user cannot dismantle the lighting fixtures directly, otherwise it may damage the lighting fixtures.
- Please do not use lighting fixtures around the mental area and high magnetic field, otherwise, it will badly affect the control distance.
- Users must be correct, strict and solid to install the lighting fixtures; do not use the lighting fixtures on strenuous vibration area.
- The lighting fixtures will be heating on working, pls do not cover the lighting housing.

9. Packing list

Name								
Quantity	3 PCS	3 PCS	1 PC	1 PC	2 PCS	2 PCS	1 PC	1 PC