

NOTE:

1. PANEL FRAME:SPCC CARBON STEEL T=1.5MM POWDER COATING
2. PANEL bracket SPCC NICKEL PLATING
3. BODY COLOR: GREY RAL7035
4. RoHS2.0 AND REACH Compliant
5. Apply to the keystone jack which the width less than 17.4mm

"1 2 3.....24" Color: black Font : Arial H:3.35MM

6. PACKING:1pcs/panel box+lable, 5pcs/carton

Accessory:

1. Cable Tie(140×3.0mm)×24Pcs
2. Screw and Nut M6*18mm × 4set

LOGO:



"SYNERGY2 "for black printing, The pantone of colour is black C
 "1" for blue printing, The pantone of colour is 298C

		UPDATE PACKING TYPE	2018-03-20	A4						
		REMOVE THE BLACK SQUARES	2014-01-08	A3	SYNERGY 21					
		UPDATE LOGO	2013-10-23	A2	CUSTOMER		ITEM NO.	S216321		
		UPDATE COMPLIANT	2013-07-10	A1	PRODUCT NAME	CAT. 6A STP 24port BLANK PATCH PANEL GREY	manufacture country	China	UNIT	MM
		NEW	2011-07-11	A	DRAWNBY	CHECKBY	APPOBY	DATE		
BY	CHK	REVISION RECORD MODIFICATIONS	DATE	REV.	SYNERGY 21	SYNERGY 21	SYNERGY 21	2018-03-20		

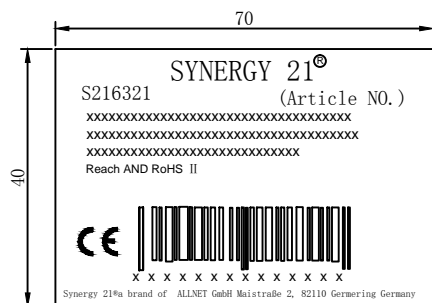

Label 1

SHIPPING MARK



PO NO. :
REACH and ROHS 2.0 Compliant
MADE IN CHINA

SIDE MARK

PO NO. :
Item no:
Q' TY:
N. W
G. W
Carton no.
MEAS.

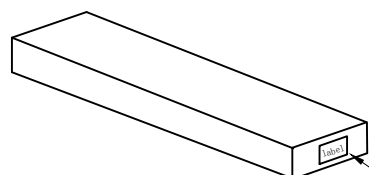

label 1

1pcs/box+Label 1

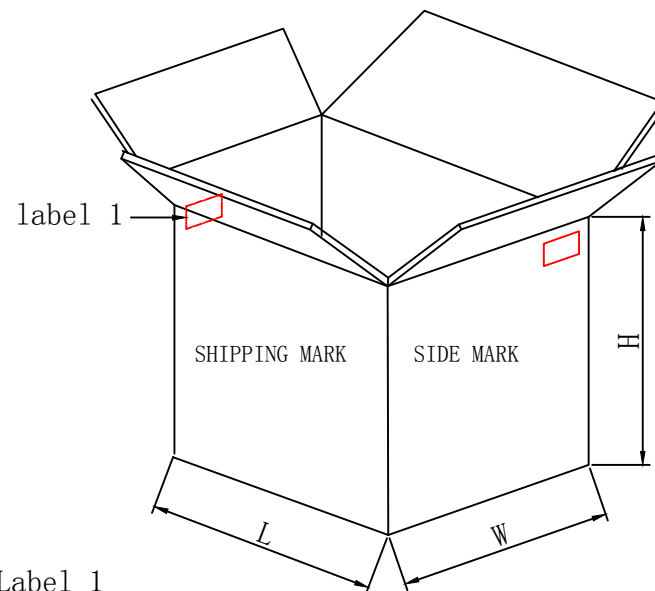
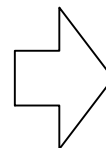
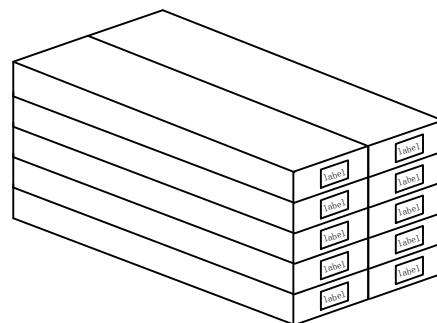
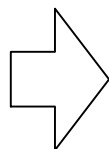

10pcs/Carton+Label 1

NOTE:

1. 1pcs/box+Label 1, 10pcs/Carton+Label 1
2. “工” type sealing
3. “井” type packaging

SYNERGY 21													
CUSTOMER			ITEM NO.			S216321							
UPDATE PACKING TYPE			2018-03-20		A4		PRODUCT NAME		Packing	manufacture country:	CHINA	UNIT	MM
NEW							DRAWNBY		CHECKBY		APPOBY		DATE
BY	CHK	REVISION RECORD MODIFICATIONS			DATE	REV.	SYNERGY 21		SYNERGY 21		SYNERGY 21		2018-03-20

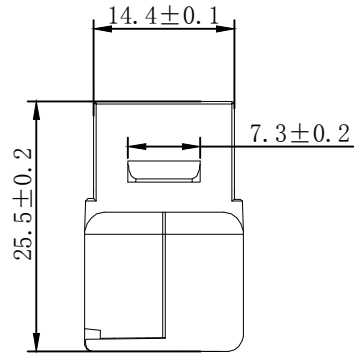
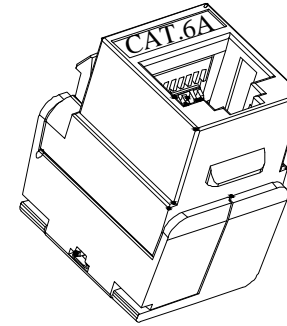
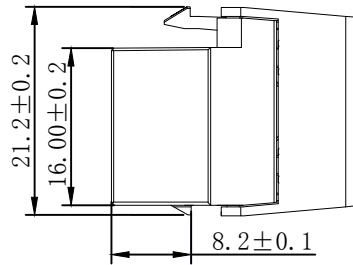
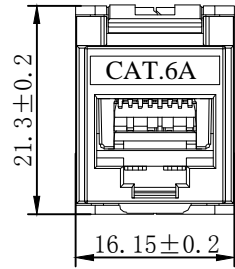

NOTES:

ELECTRICAL:

1. Contact Resistance : 20MΩ MAX
2. Insulation Resistance : 500MΩ MIN @ 500V DC
3. Withstand Voltage : DC 1000V AC 700V RMS 60Hz, 1MIN
4. Component testing for Cat.6A to ISO/IEC 11801 Ed.2.2:2011-06
 DIN EN 50173-1:2011-09
 TIA/EIA-568-C.2 (2009-08)
 IEC 60603-7-5
5. Compliance with Class EA up to 500 MHz to ISO/IEC 11801 Ed.2.2:2011-06
 DIN EN 50173-1:2011-09

ENVIRONMENTAL:

1. Storage : -40° TO+70°
2. Operation : -10° to+60°

MECHANICAL

1. SHIELD MATERIAL: ZINC ALLOY
2. IDC MATERIAL: PC TERMINAL:PHOSPHOR BRONZE, TIN PLATING
3. RJ45 Contact Life: 750 Times Min
4. Plug inforce:<30N
5. Solid cable:1/22AWG(0.65MM)-1/24AWG(0.45MM) ID:0.8MM-1.6MM
6. Cable OD: 5.0mm-8.5mm
7. PoE per IEEE 802.3af, PoE+ per IEEE 802.3at

Fluke Test:Permanent Link ISO 11801 (PL2)Class Ea 1000MHZ
 AWG23/1 CAT.7 Shielded 15M
 RoHS(EU2015/863) and REACH Compliant
 PACKING:1PCS/PE BAG

MATERIAL LIST:

⑦	MODULAR COVER	White/PC with T568A/B label	1	
⑥	RJ 45 JACK INSERT	PHOSPHOR BRONZE 8P8C 6U" GOLD PLATED	8	
⑤	PCB	1.6mm UL 94V0	1	
④	IDC BODY	White/PC	1	
③	IDC PIN	PHOSPHOR BRONZE & TINNED	8	
②	LABEL COLOR CODE	T568A/B	2	
①	IDC TERMINAL	FOR 22-24AWG(0.45mm-0.65mm) CABLE	1	

NO	PARTS NAME	SPECIFICATION STANDARD	QT' Y	REMARK
		NEW	2019-05-09	A
BY	CHK	REVISION RECORD MODIFICATIONS	DATE	REV.

SYNERGY 21					
CUSTOMER			ITEM NO.	S216349	
PRODUCT NAME	CAT.6A STP KEYSTONE JACK	manufacture country:	china	UNIT	MM
DRAWNBY	CHECKBY	APPOBY	DATE		
SYNERGY 21	SYNERGY 21	SYNERGY 21	2019-05-09		

Montageanleitung/Installation Instruction

Super short body Cat.6A Keystone Jack

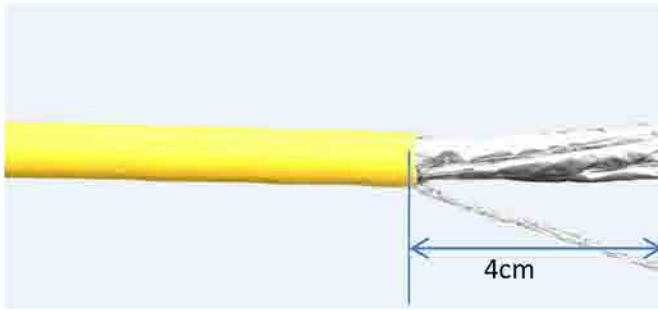

- ①. Stripping off approx. 4cm, twist the braiding into a strand. Remove the pair shielding.

- ①. Ca. 4 cm abziehen und das Geflecht zu einer Litze verweben. Entfernen Sie die Paarabschirmung.

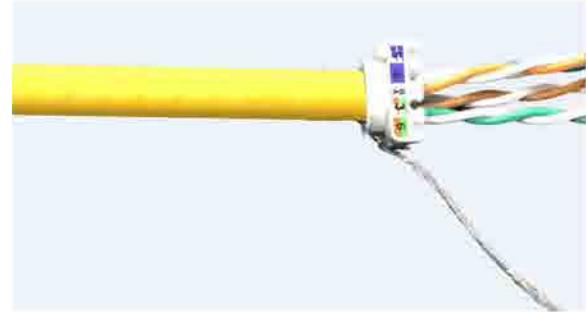

- ②. Pass the cable wires into grommet without the strand as shown in the photo.

- ②. Führen Sie die Kabeldrähte ohne die Litze in die Durchführung ein (siehe Foto).

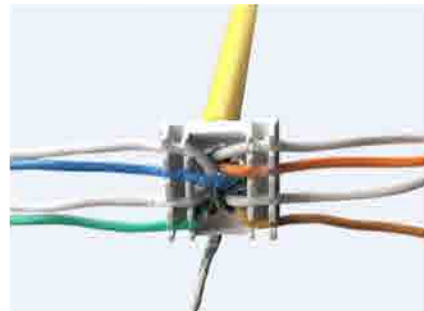

- ③. Insert each wire in its location according to the color code.

- ③. Legen Sie jeden Draht gemäß dem Farbcode an seiner Stelle ein

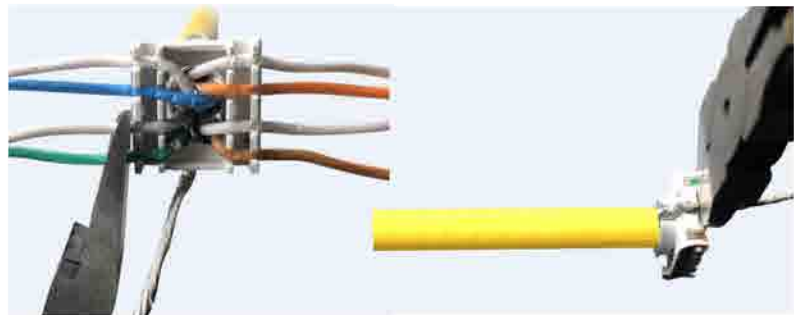

- ④. Cut the wires and the strand.

- ④. Schneiden Sie die Drähte und die Litze ab.



- ⑤. Make sure that the arrows of the jack are oriented in the same direction as those of the grommet.

- ⑤. Stellen Sie sicher, dass die Pfeile des Wagenhebers in die gleiche Richtung wie die der Tülle zeigen.



- ⑥. Connect the grommet to the connector.

- ⑥. Verbinden Sie die Tülle mit dem Anschluss.

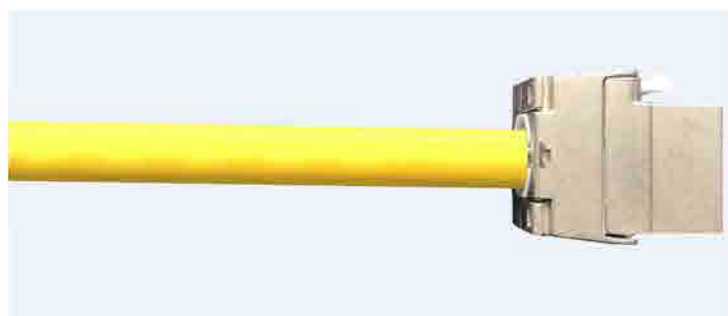

- ⑦. Fold the cheeks of the RJ45 jack until completely closed.

- ⑦. Falten Sie die Wangen der RJ45-Buchse, bis sie vollständig geschlossen sind.